

1 EXAMPLE POST LAYOUT
PLAN VIEW

NOTES:

1. TOP RAIL NOT SHOWN FOR CLARITY.
2. ALL PARTS AND COMPONENTS MADE WITH 316 STAINLESS STEEL UNLESS NOTED OTHERWISE.

LEGEND

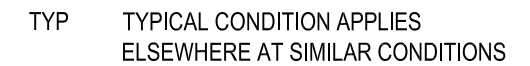
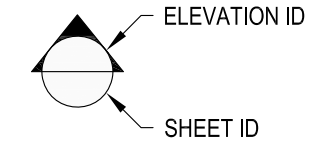
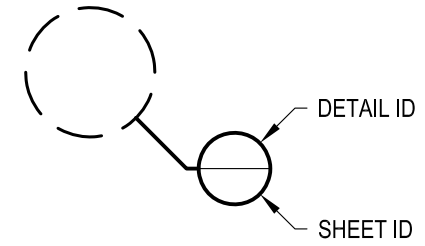

DATE	2024
SCALE	NONE
DESIGNER	AGS
SHEET	1 OF 4

OLYMPUS SPECIFICATION DRAWING
** COMMERCIAL **

42" TOP MOUNT - ROUND TOP

7873 NE DAY ROAD
BAMBRIDGE ISLAND, WA 98110
PHONE - (888) 842-9492
FAX - (206) 842-8179
WWW.AGSSTAINLESS.COM



NOTES:

1. DECK STRUCTURE CAN VARY GREATLY. IT IS THE RESPONSIBILITY OF THE CUSTOMER TO VERIFY THAT THE SUPPORTING STRUCTURE IS ADEQUATE TO MEET THE LOAD REQUIREMENTS OF THE GOVERNING BUILDING CODE(S). *AGS Stainless Inc.* RECOMMENDS CONSULTING A DESIGN OR CONSTRUCTION PROFESSIONAL TO ADDRESS THESE ISSUES.

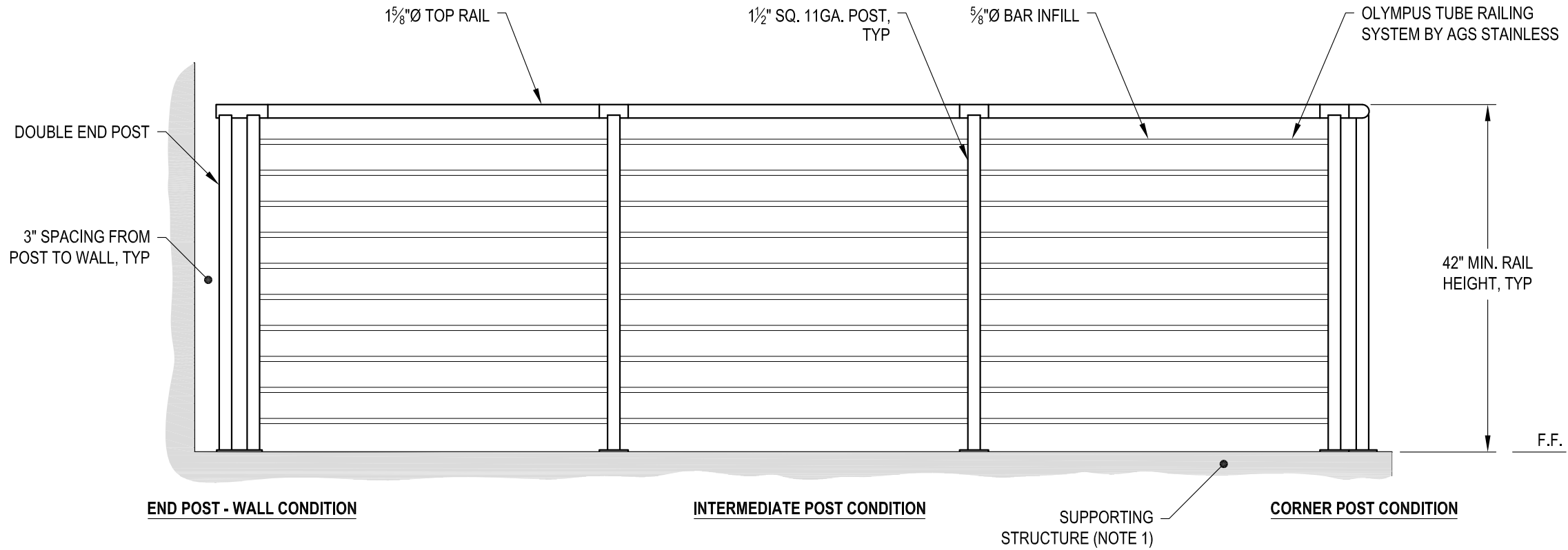

A TYPICAL RAILING CONDITION ELEVATION

DWS*	OLYMPUS TM42RC	DATE	2024
	SCALE	NONE	SHEET
DESIGNER		AGS	2 OF 4

OLYMPUS SPECIFICATION DRAWING
 ** COMMERCIAL **
 42" TOP MOUNT - ROUND TOP

7873 NE DAY ROAD
 BAINBRIDGE ISLAND, WA 98110
 PHONE - (888) 842-9492
 FAX - (206) 842-8179
 WWW.AGSSTAINLESS.COM

AGS stainless
 CLEARVIEW® Railing Systems

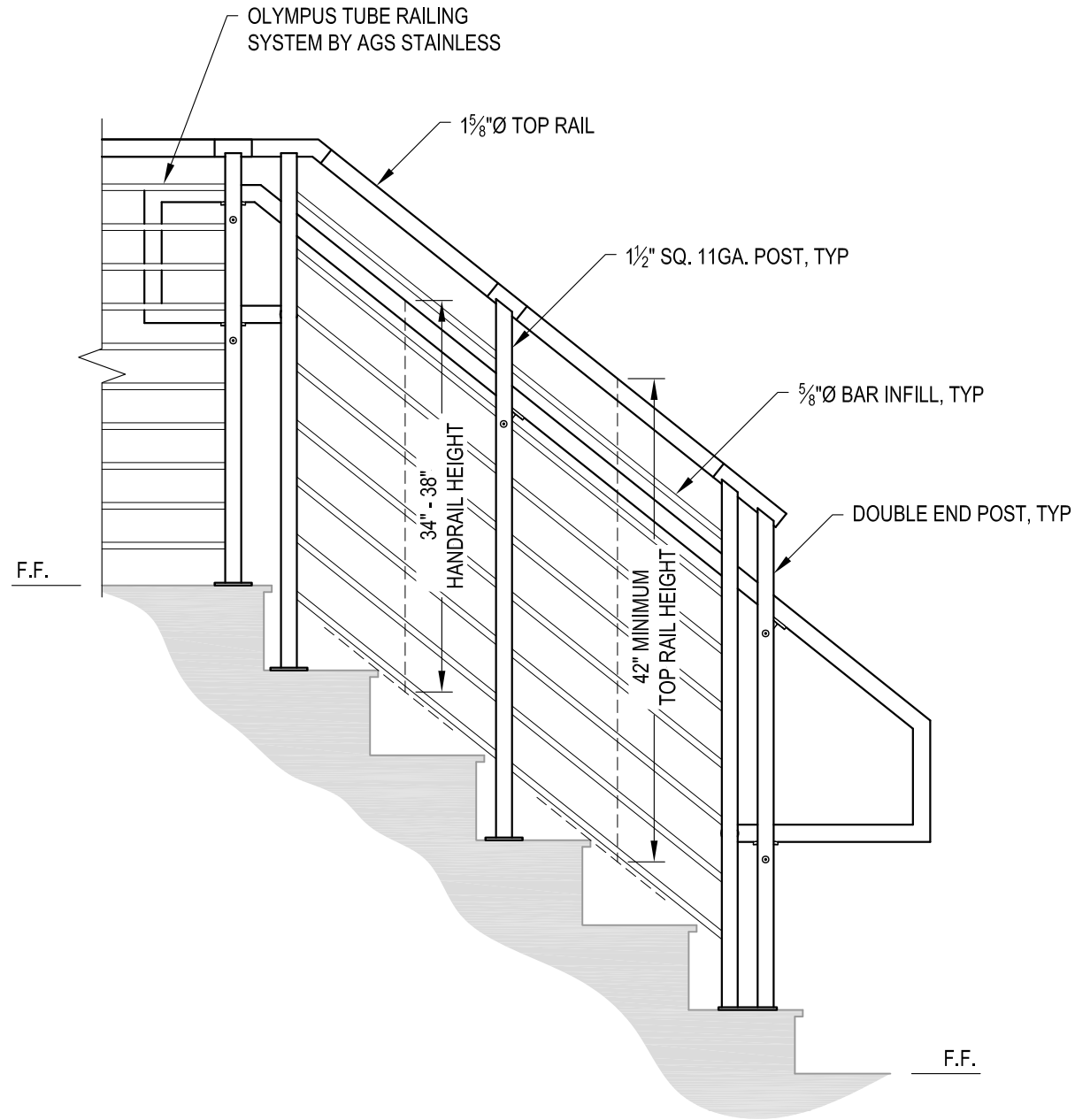

A STAIR
ELEVATION

NOTES:

1. STAIR CONSTRUCTION VARIES GREATLY. AS-BUILT CONDITIONS MAY ALTER RAILING DESIGN, INCLUDING POST LOCATION & MOUNTING, INFILL SPACING & TOP RAIL LAYOUT.

AGS Stainless Clearview® Railing Systems are designed to meet the requirements of the latest edition of the IRC/IBC.

OLYMPUS SPECIFICATION DRAWING ** COMMERCIAL ** 42" TOP MOUNT - ROUND TOP	OLYMPUS TM42RC
	DATE 2024 SHEET 3 OF 4
7873 MEADY ROAD BAINBRIDGE ISLAND, WA 98110 PHONE - (888) 842-9492 FAX - (206) 842-8779 WWW.AGSSTAINLESS.COM	AGS stainless <small>CLEARVIEW® Railing Systems</small>
ONS* SCALE NONE DESIGNER AGS	

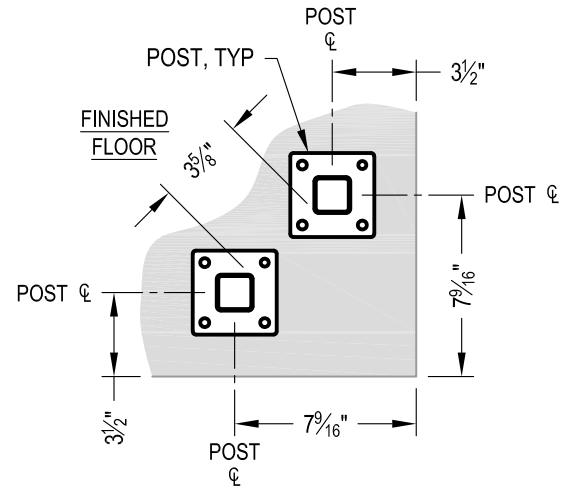

NOTE: 90° SHOWN, OTHER ANGLES SIMILAR

A TYPICAL TOP MOUNT OUTSIDE CORNER
DETAIL

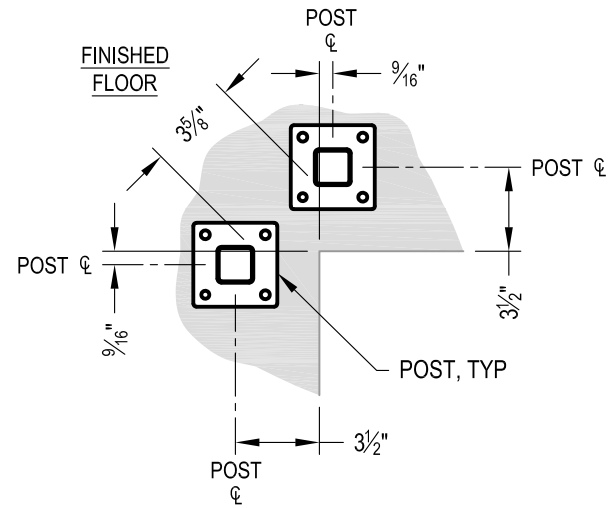

NOTE: 90° SHOWN, OTHER ANGLES SIMILAR

B TYPICAL TOP MOUNT INSIDE CORNER
DETAIL

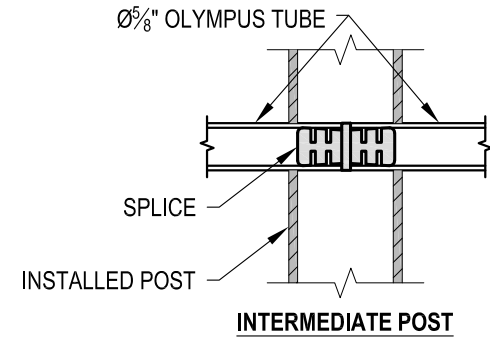
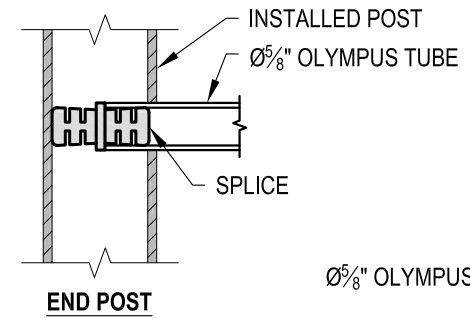

C FITTING INSTALLATION - OLYMPUS SPLICE
DETAIL

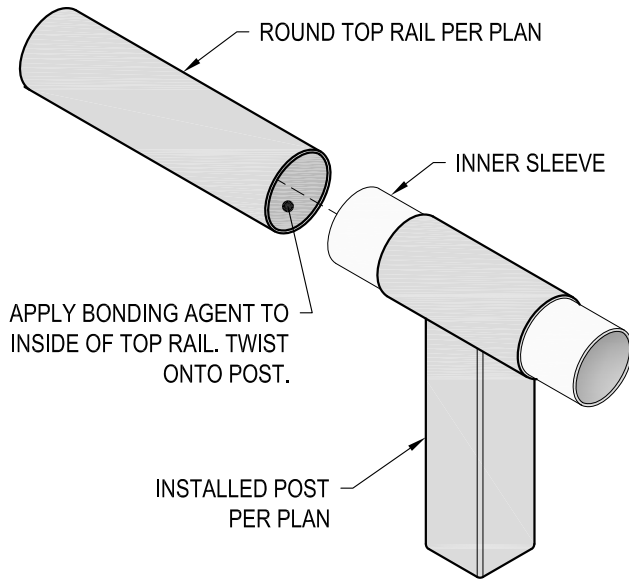

D TOP RAIL INSTALLATION - ROUND
DETAIL

AGS Stainless Clearview® Railing Systems are designed to meet the requirements of the latest edition of the IRC/IBC.

DATE	2024
SCALE	NONE
DESIGNER	AGS
SHEET	4 OF 4

OLYMPUS SPECIFICATION DRAWING
** COMMERCIAL **
42" TOP MOUNT - ROUND TOP

7873 MEADY ROAD
BAINBRIDGE ISLAND, WA 98110
PHONE - (888) 842-9492
FAX - (206) 842-8179
WWW.AGSSTAINLESS.COM

