

1 EXAMPLE POST LAYOUT
PLAN VIEW

NOTES:

1. TOP RAIL NOT SHOWN FOR CLARITY.
2. ALL PARTS AND COMPONENTS MADE WITH 316 STAINLESS STEEL UNLESS NOTED OTHERWISE.

LEGEND

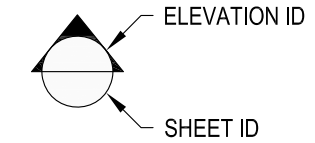
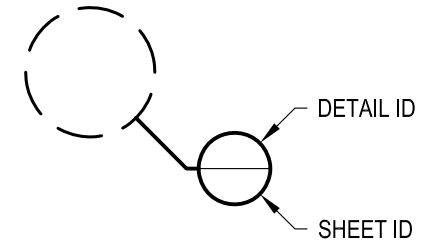

□ CORE MOUNT POST

□ □ CORE MOUNT DOUBLE POST

☒ CENTERLINE

F.F. FINISHED FLOOR

TYP TYPICAL CONDITION APPLIES ELSEWHERE AT SIMILAR CONDITIONS

OLYMPUS CM42R	DATE	2024
SCALE	NONE	
DESIGNER	AGS	SHEET
		1 OF 4

OLYMPUS SPECIFICATION DRAWING
** RESIDENTIAL **

42" CORE MOUNT - ROUND TOP

7873 NE DAY ROAD
BAMBRIDGE ISLAND, WA 98110
PHONE - (888) 842-9492
FAX - (206) 842-8179
WWW.AGSSTAINLESS.COM



NOTES:

1. DECK STRUCTURE CAN VARY GREATLY. IT IS THE RESPONSIBILITY OF THE CUSTOMER TO VERIFY THAT THE SUPPORTING STRUCTURE IS ADEQUATE TO MEET THE LOAD REQUIREMENTS OF THE GOVERNING BUILDING CODE(S). *AGS Stainless Inc.* RECOMMENDS CONSULTING A DESIGN OR CONSTRUCTION PROFESSIONAL TO ADDRESS THESE ISSUES.

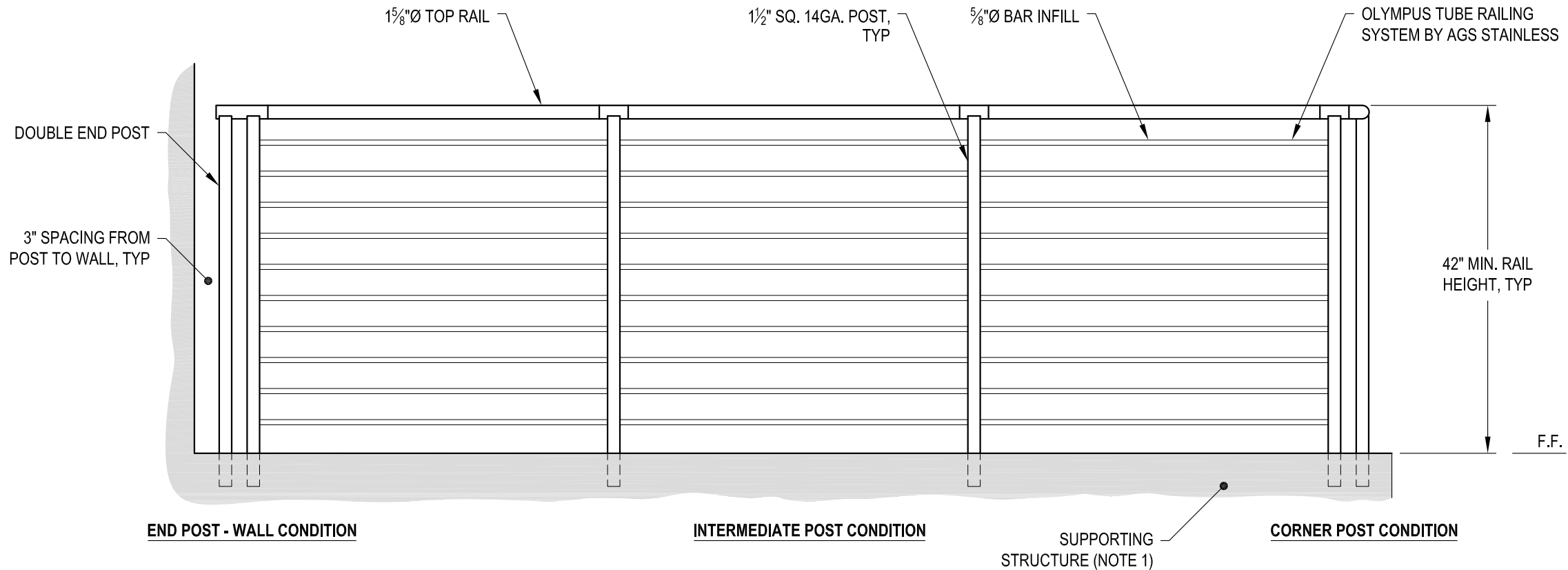

A TYPICAL RAILING CONDITION ELEVATION

DATE	2024	SHEET	2 OF 4
SCALE	NONE		
DESIGNER	AGS		

OLYMPUS SPECIFICATION DRAWING
 ** RESIDENTIAL **
 42" CORE MOUNT - ROUND TOP

7873 NE DAY ROAD
 BAINBRIDGE ISLAND, WA 98110
 PHONE - (888) 842-9492
 FAX - (206) 842-8779
 WWW.AGSSTAINLESS.COM



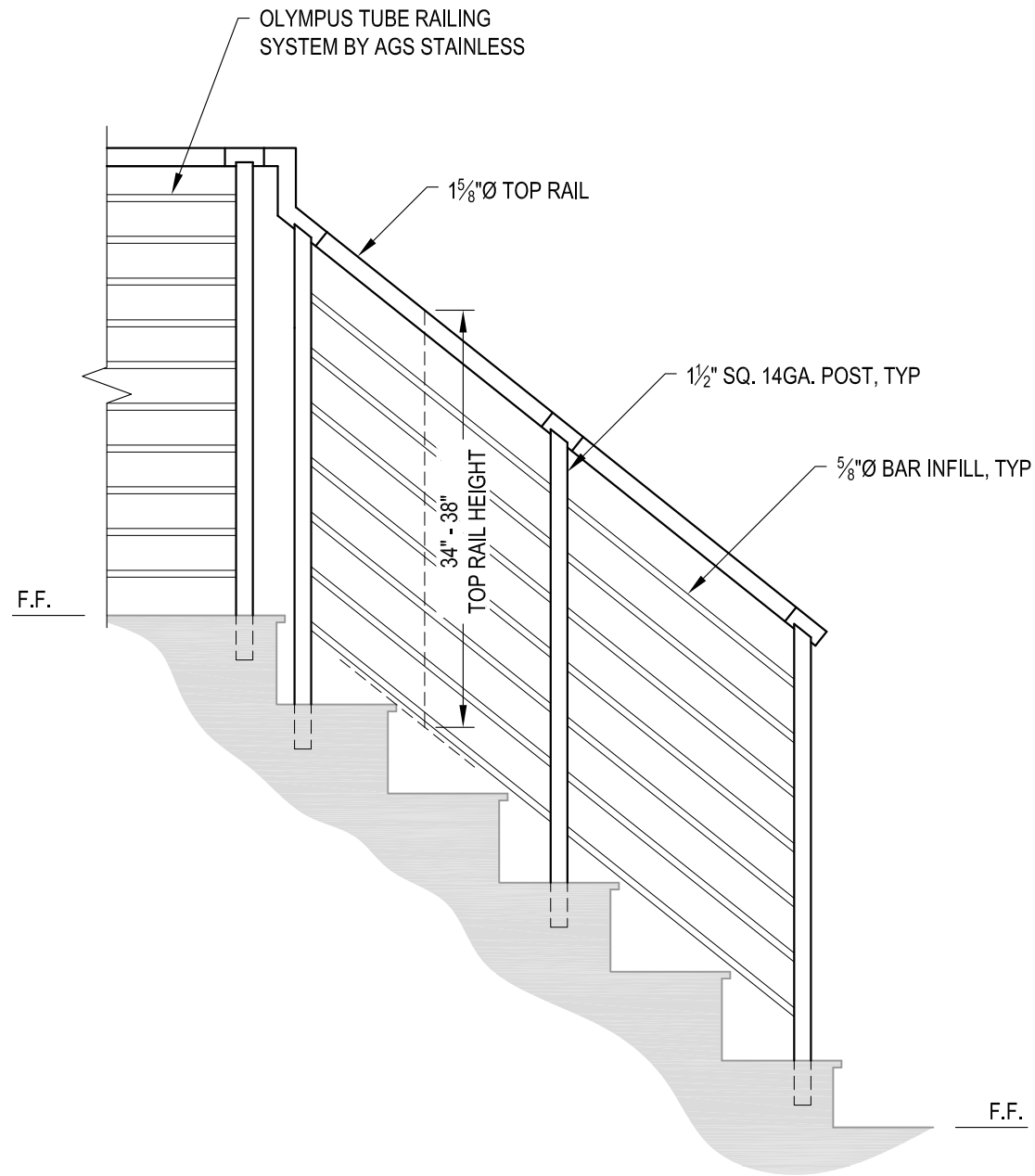

A STAIR
ELEVATION

NOTES:

1. STAIR CONSTRUCTION VARIES GREATLY. AS-BUILT CONDITIONS MAY ALTER RAILING DESIGN, INCLUDING POST LOCATION & MOUNTING, INFILL SPACING & TOP RAIL LAYOUT.

AGS Stainless Clearview® Railing Systems are designed to meet the requirements of the latest edition of the IRC/IBC.

OLYMPUS SPECIFICATION DRAWING ** RESIDENTIAL ** 42" CORE MOUNT - ROUND TOP	OLYMPUS CM42R	2024	3 OF 4
	NONE	AGS	SHEET
7873 MEADY ROAD BAINBRIDGE ISLAND, WA 98110 PHONE - (888) 842-9492 FAX - (206) 842-8179 WWW.AGSSTAINLESS.COM			

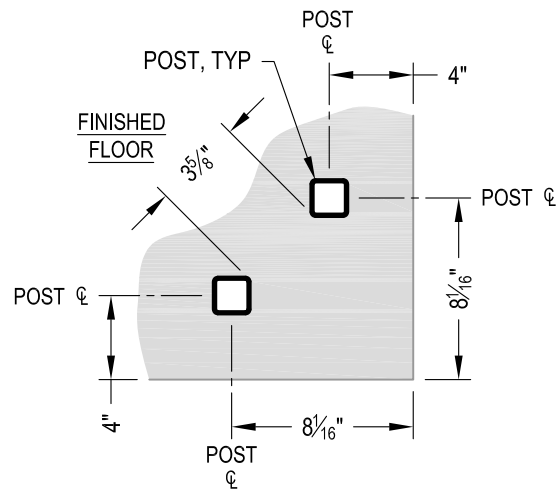

NOTE: 90° SHOWN, OTHER ANGLES SIMILAR

A TYPICAL 90° CORE MOUNT OUTSIDE CORNER
DETAIL

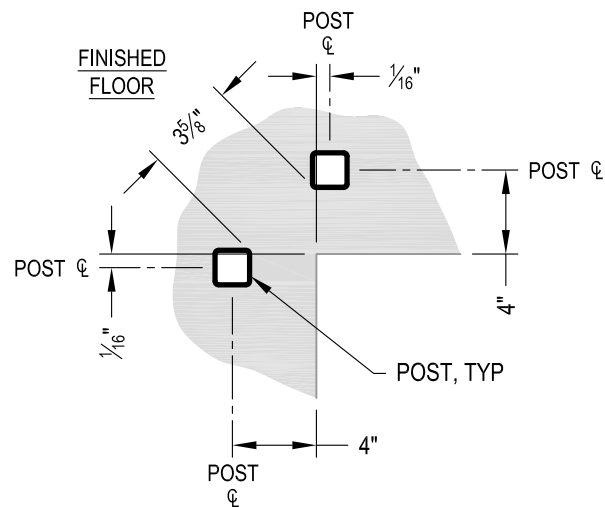

NOTE: 90° SHOWN, OTHER ANGLES SIMILAR

B TYPICAL 90° CORE MOUNT INSIDE CORNER
DETAIL

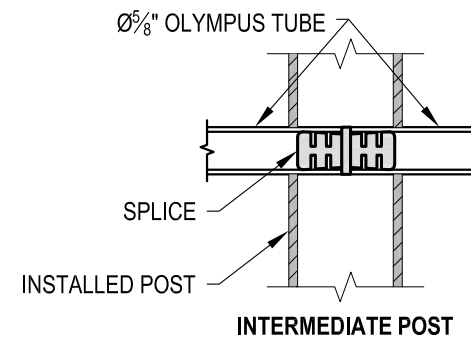
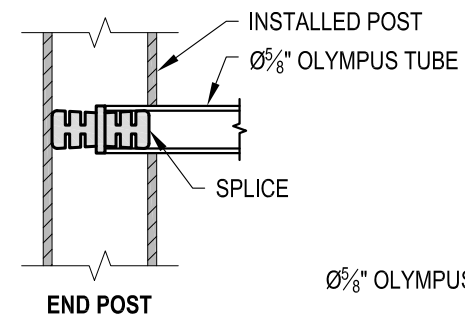

C FITTING INSTALLATION - OLYMPUS SPLICE
DETAIL

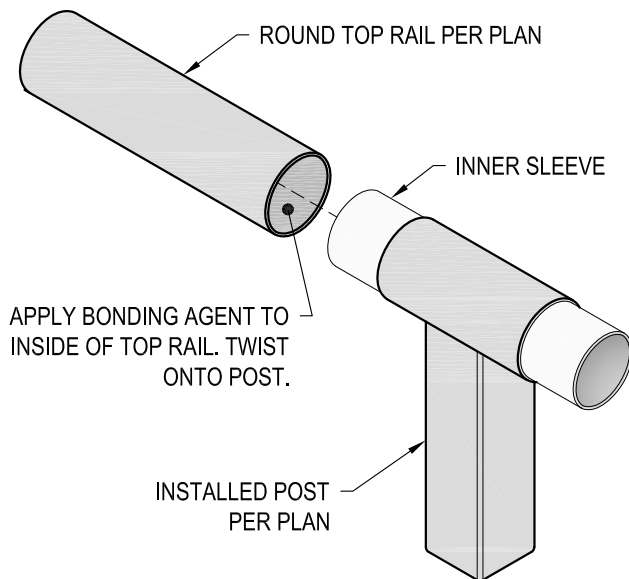

D TOP RAIL INSTALLATION - ROUND
DETAIL

OLYMPUS SPECIFICATION DRAWING ** RESIDENTIAL **	OLYMPUS CM42R	DATE 2024	SHEET 4 OF 4
	SCALE NONE	DESIGNER AGS	
42" CORE MOUNT - ROUND TOP			
7873 ME DAY ROAD BAINBRIDGE ISLAND, WA 98110 PHONE - (888) 842-9492 FAX - (206) 842-8779 WWW.AGSSTAINLESS.COM			