

**1** EXAMPLE POST LAYOUT  
PLAN VIEW

**NOTES:**

1. TOP RAIL NOT SHOWN FOR CLARITY.
2. ALL PARTS AND COMPONENTS MADE WITH 316 STAINLESS STEEL UNLESS NOTED OTHERWISE.

**LEGEND**

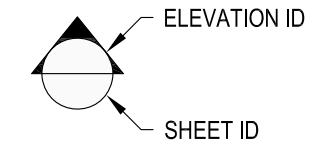
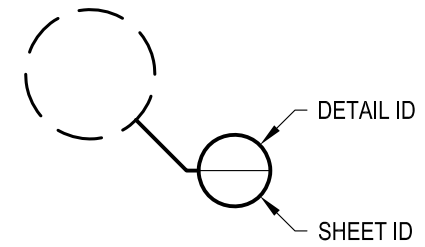

□ SIDE MOUNT POST

☒ CENTERLINE

F.F. FINISHED FLOOR

TYP TYPICAL CONDITION APPLIES  
ELSEWHERE AT SIMILAR CONDITIONS

OLYMPUS SM36F	DATE	2024
SCALE	NONE	
DESIGNER	AGS	SHEET
		1 OF 4

OLYMPUS SPECIFICATION DRAWING  
\*\* RESIDENTIAL \*\*

36" SIDE MOUNT - FLAT TOP

7873 NE DAY ROAD  
BAMBRIDGE ISLAND, WA 98110

PHONE - (888) 842-9492  
FAX - (206) 842-8179  
WWW.AGSSTAINLESS.COM



**NOTES:**

1. DECK STRUCTURE CAN VARY GREATLY. IT IS THE RESPONSIBILITY OF THE CUSTOMER TO VERIFY THAT THE SUPPORTING STRUCTURE IS ADEQUATE TO MEET THE LOAD REQUIREMENTS OF THE GOVERNING BUILDING CODE(S). *AGS Stainless Inc.* RECOMMENDS CONSULTING A DESIGN OR CONSTRUCTION PROFESSIONAL TO ADDRESS THESE ISSUES.

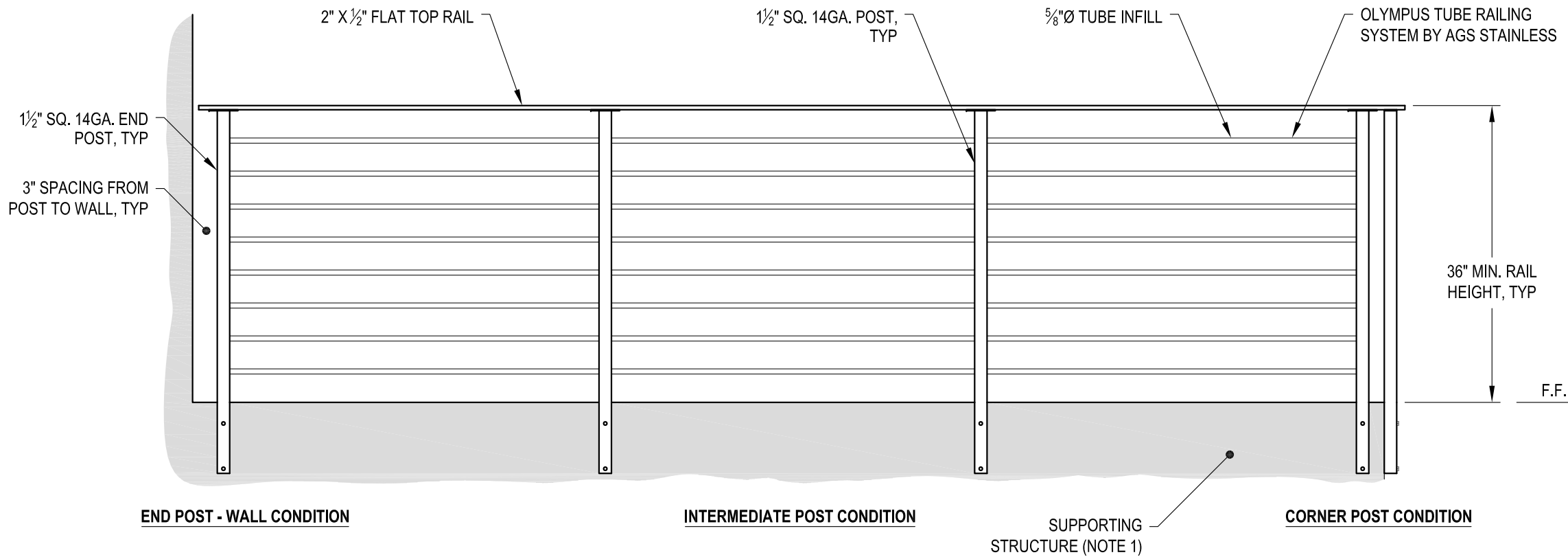

DATE	OLYMPUS SM36F
SCALE	NONE
DESIGNER	AGS
DATE	2024
SHEET	2 OF 4

OLYMPUS SPECIFICATION DRAWING  
 \*\* RESIDENTIAL \*\*  
 36" SIDE MOUNT - FLAT TOP

7873 NE DAY ROAD  
 BAINBRIDGE ISLAND, WA 98110  
 PHONE - (888) 842-9492  
 FAX - (206) 842-8179  
 WWW.AGSSTAINLESS.COM



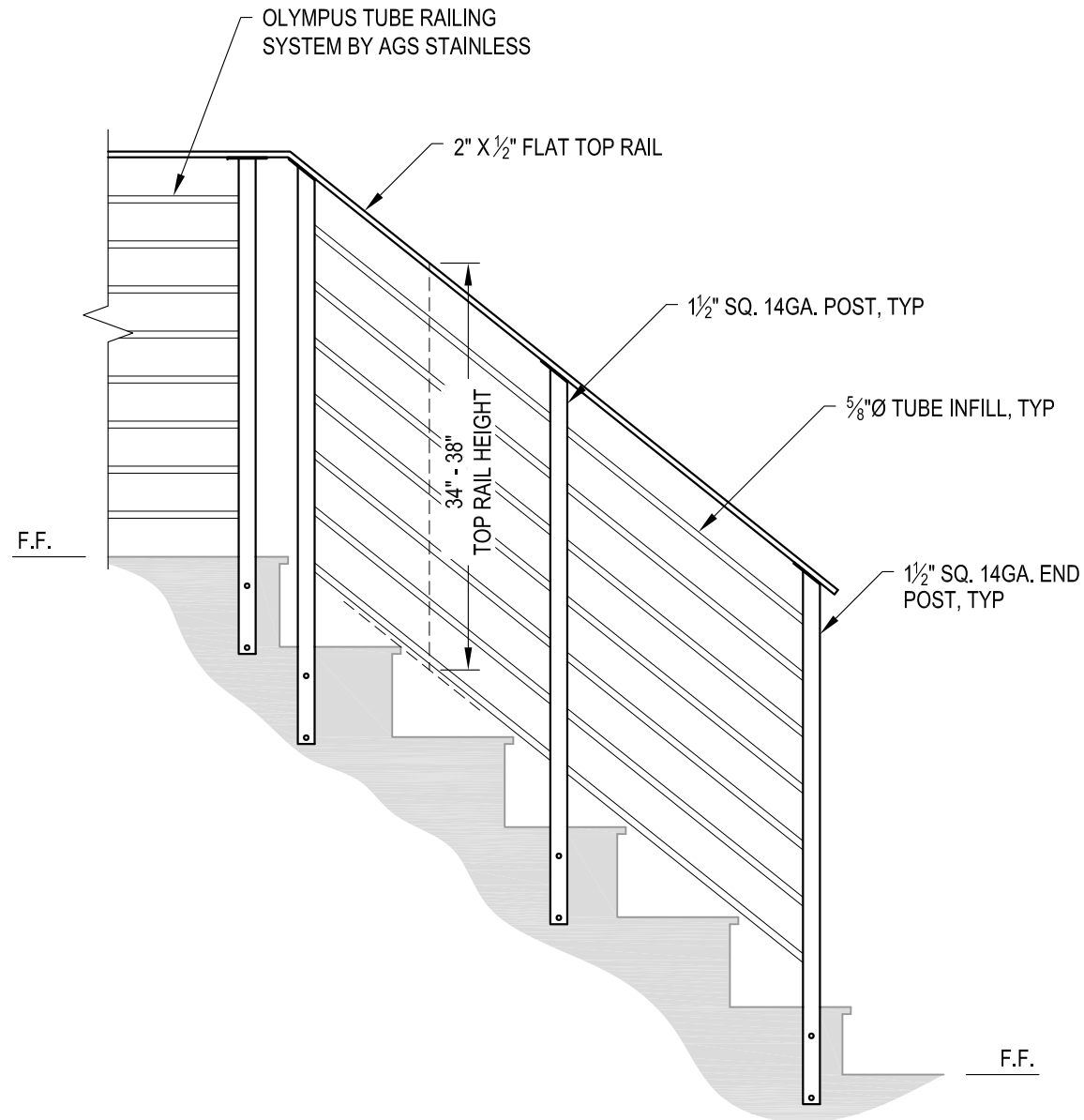

**A** STAIR ELEVATION

**NOTES:**

1. STAIR CONSTRUCTION VARIES GREATLY. AS-BUILT CONDITIONS MAY ALTER RAILING DESIGN, INCLUDING POST LOCATION & MOUNTING, INFILL SPACING & TOP RAIL LAYOUT.

AGS Stainless Clearview® Railing Systems are designed to meet the requirements of the latest edition of the IRC/IBC.

DATE	2024	SHEET	3 OF 4
SCALE	NONE		
DESIGNER	AGS		

OLYMPUS SPECIFICATION DRAWING  
 \*\* RESIDENTIAL \*\*

36" SIDE MOUNT - FLAT TOP

7873 MEADY ROAD  
 BAINBRIDGE ISLAND, WA 98110  
 PHONE - (888) 842-9492  
 FAX - (206) 842-8779  
 WWW.AGSSTAINLESS.COM



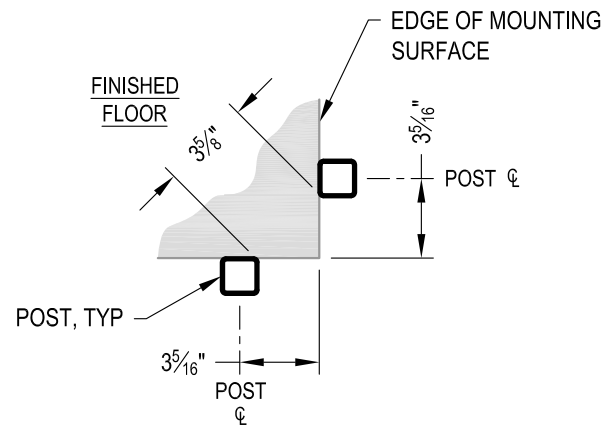

NOTE: 90° SHOWN, OTHER ANGLES SIMILAR

**A** TYPICAL SIDE MOUNT OUTSIDE CORNER  
DETAIL

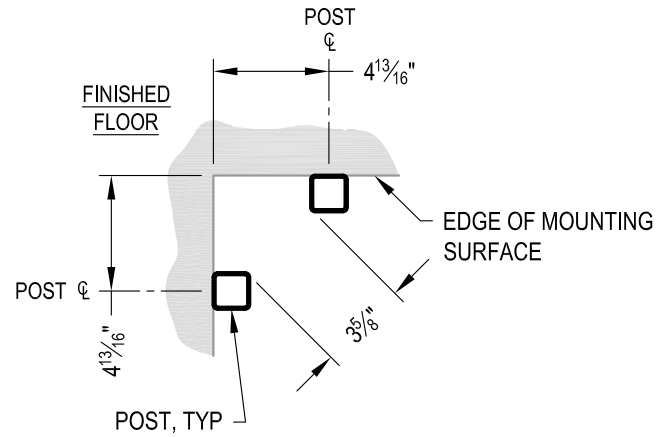

NOTE: 90° SHOWN, OTHER ANGLES SIMILAR

**B** TYPICAL SIDE MOUNT INSIDE CORNER  
DETAIL

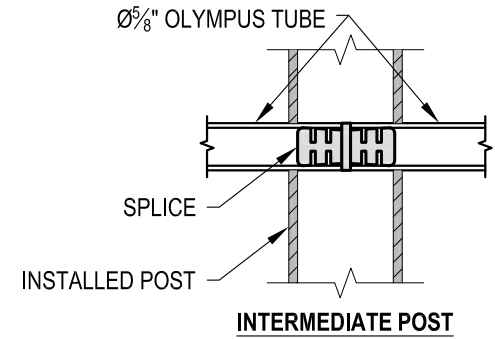
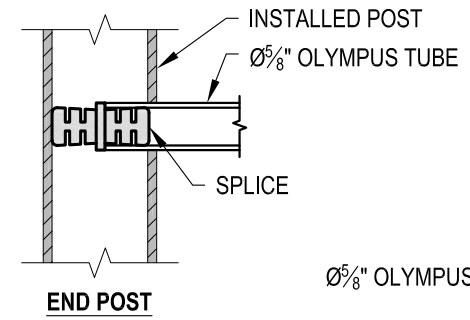

**C** FITTING INSTALLATION - OLYMPUS SPLICE  
DETAIL

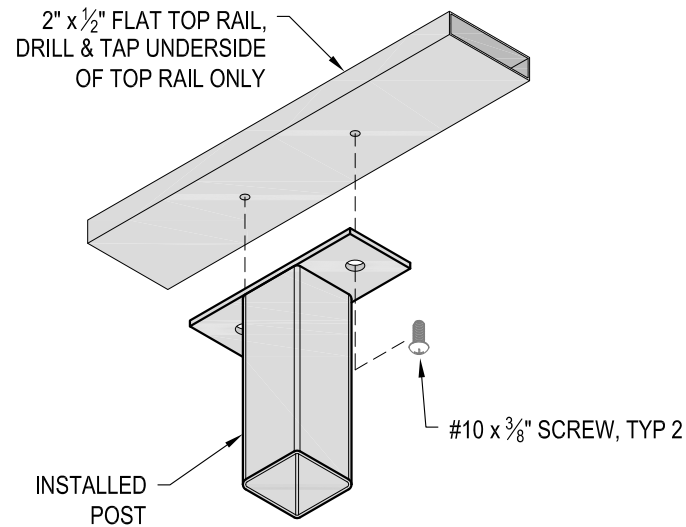

**D** TOP RAIL INSTALLATION - FLAT  
DETAIL