

1 EXAMPLE POST LAYOUT
PLAN VIEW

NOTES:

1. TOP RAIL NOT SHOWN FOR CLARITY.
2. ALL PARTS AND COMPONENTS MADE WITH 316 STAINLESS STEEL UNLESS NOTED OTHERWISE.

LEGEND

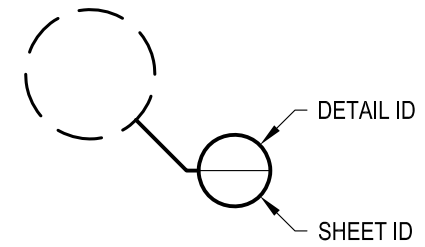

□ SIDE MOUNT POST

☒ CENTERLINE

F.F. FINISHED FLOOR

TYP TYPICAL CONDITION APPLIES ELSEWHERE AT SIMILAR CONDITIONS

OLYMPUS SM36R	DATE	2024
SCALE	NONE	
DESIGNER	AGS	SHEET
		1 OF 4

OLYMPUS SPECIFICATION DRAWING
** RESIDENTIAL **
36" SIDE MOUNT - ROUND TOP

7873 NE DAY ROAD
BAMBRIDGE ISLAND, WA 98110
PHONE - (888) 842-9492
FAX - (206) 842-8179
WWW.AGSSTAINLESS.COM



NOTES:

- DECK STRUCTURE CAN VARY GREATLY. IT IS THE RESPONSIBILITY OF THE CUSTOMER TO VERIFY THAT THE SUPPORTING STRUCTURE IS ADEQUATE TO MEET THE LOAD REQUIREMENTS OF THE GOVERNING BUILDING CODE(S). *AGS Stainless Inc.* RECOMMENDS CONSULTING A DESIGN OR CONSTRUCTION PROFESSIONAL TO ADDRESS THESE ISSUES.

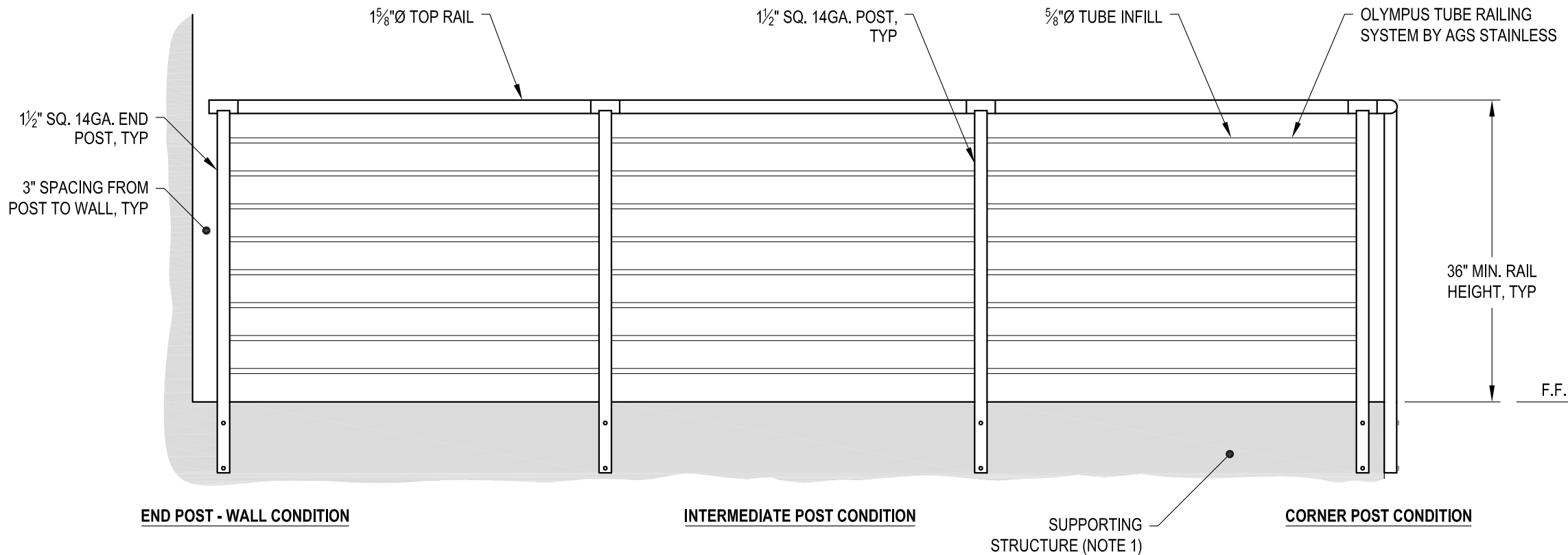

A TYPICAL RAILING CONDITION ELEVATION

OLYMPUS SM36R	DATE	2024
SCALE	NONE	SHEET
DESIGNER	AGS	2 OF 4

OLYMPUS SPECIFICATION DRAWING
 ** RESIDENTIAL **
 36" SIDE MOUNT - ROUND TOP

7873 NE DAY ROAD
 BAINBRIDGE ISLAND, WA 98110
 PHONE - (888) 842-9492
 FAX - (206) 842-8179
 WWW.AGSSTAINLESS.COM



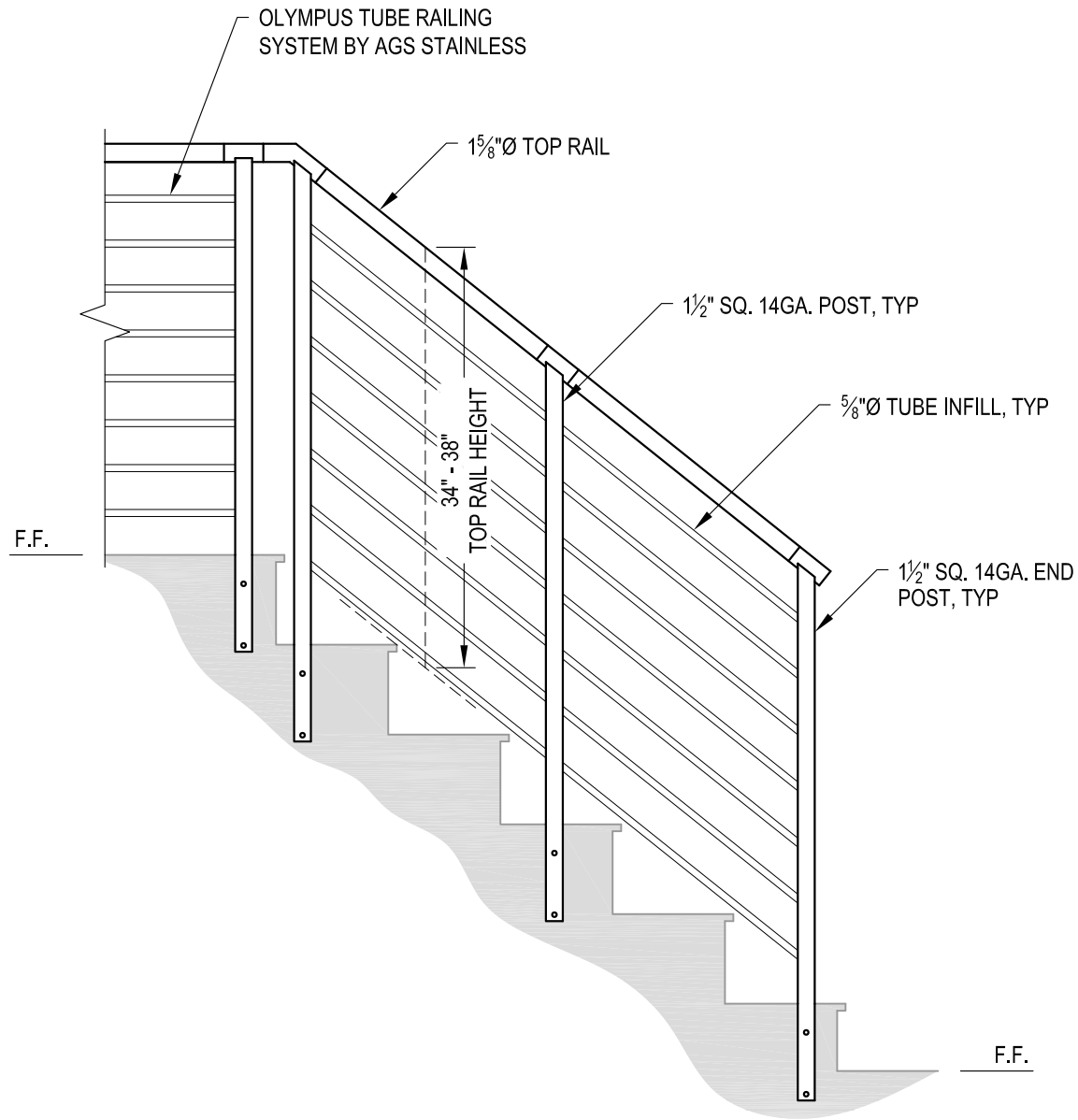

A STAIR
ELEVATION

NOTES:

1. STAIR CONSTRUCTION VARIES GREATLY. AS-BUILT CONDITIONS MAY ALTER RAILING DESIGN, INCLUDING POST LOCATION & MOUNTING, INFILL SPACING & TOP RAIL LAYOUT.

AGS Stainless Clearview® Railing Systems are designed to meet the requirements of the latest edition of the IRC/IBC.

OLYMPUS SPECIFICATION DRAWING ** RESIDENTIAL ** 36" SIDE MOUNT - ROUND TOP	OLYMPUS SM36R <small>DATE</small> 2024 <small>SHEET</small> 3 OF 4
	<small>DESIGNER</small> AGS
7873 MEADY ROAD BAINBRIDGE ISLAND, WA 98110 PHONE - (888) 842-9492 FAX - (206) 842-8779 WWW.AGSSTAINLESS.COM	

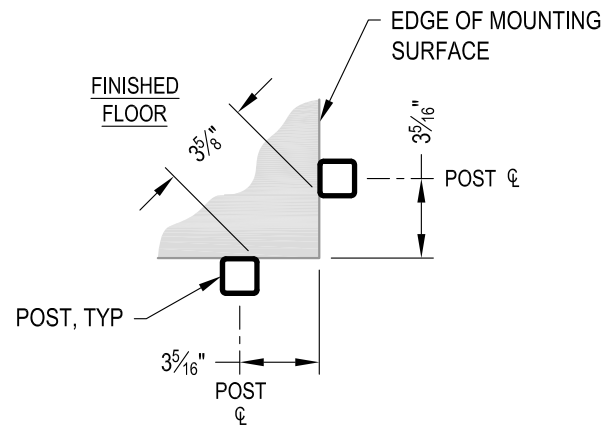

NOTE: 90° SHOWN, OTHER ANGLES SIMILAR

A TYPICAL SIDE MOUNT OUTSIDE CORNER
DETAIL

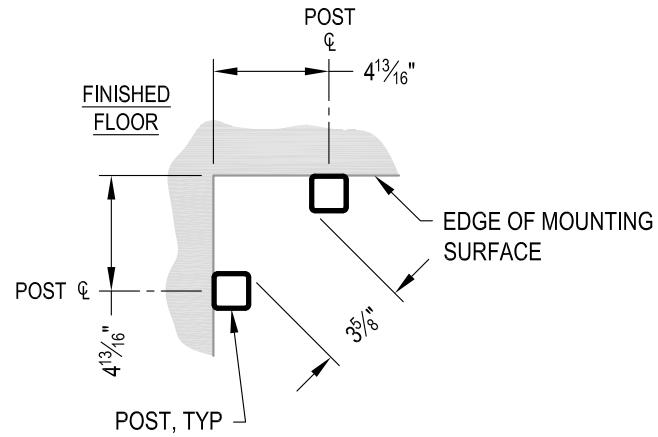

NOTE: 90° SHOWN, OTHER ANGLES SIMILAR

B TYPICAL SIDE MOUNT INSIDE CORNER
DETAIL

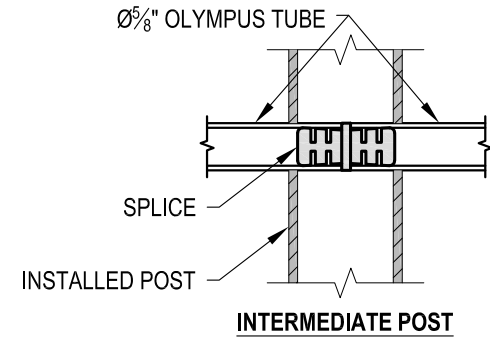
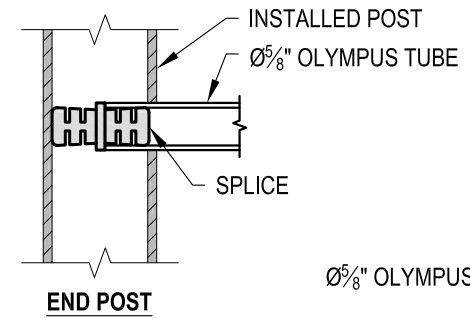

C FITTING INSTALLATION - OLYMPUS SPLICE
DETAIL

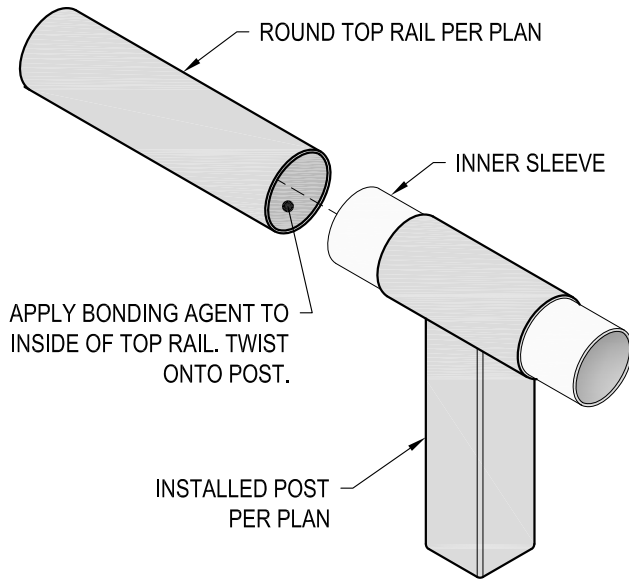

D TOP RAIL INSTALLATION - ROUND
DETAIL

AGS Stainless Clearview® Railing Systems are designed to meet the requirements of the latest edition of the IRC/IBC.