

1 EXAMPLE POST LAYOUT
PLAN VIEW

NOTES:

1. TOP RAIL NOT SHOWN FOR CLARITY.
2. ALL PARTS AND COMPONENTS MADE WITH 316 STAINLESS STEEL UNLESS NOTED OTHERWISE.

LEGEND

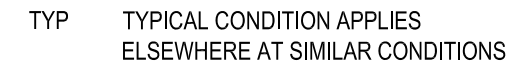
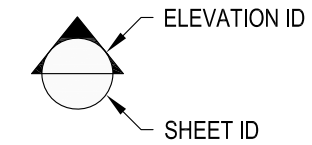
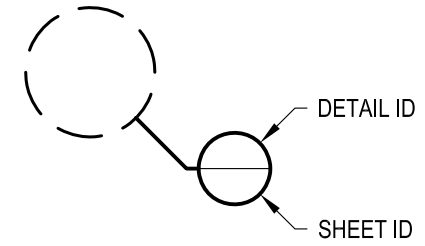

DATE	2024	DESIGNER	AGS	SHEET	1 OF 4
SCALE	NONE				
RRAINIER TM36W					

RRAINIER SPECIFICATION DRAWING
** RESIDENTIAL **

36" TOP MOUNT - WOOD TOP

7873 NE DAY ROAD
BAMBRIDGE ISLAND, WA 98110
PHONE - (888) 842-9492
FAX - (206) 842-4317
WWW.AGSSTAINLESS.COM



NOTES:

1. TOP RAIL SHOULD BE SELECTED SO THAT ALL GOVERNING CODE REQUIREMENTS ARE SATISFIED. THESE INCLUDE SHAPE, STRENGTH AND RAILING HEIGHT.
2. DECK STRUCTURE CAN VARY GREATLY. IT IS THE RESPONSIBILITY OF THE CUSTOMER TO VERIFY THAT THE SUPPORTING STRUCTURE IS ADEQUATE TO MEET THE LOAD REQUIREMENTS OF THE GOVERNING BUILDING CODE(S). *AGS Stainless Inc.* RECOMMENDS CONSULTING A DESIGN OR CONSTRUCTION PROFESSIONAL TO ADDRESS THESE ISSUES.

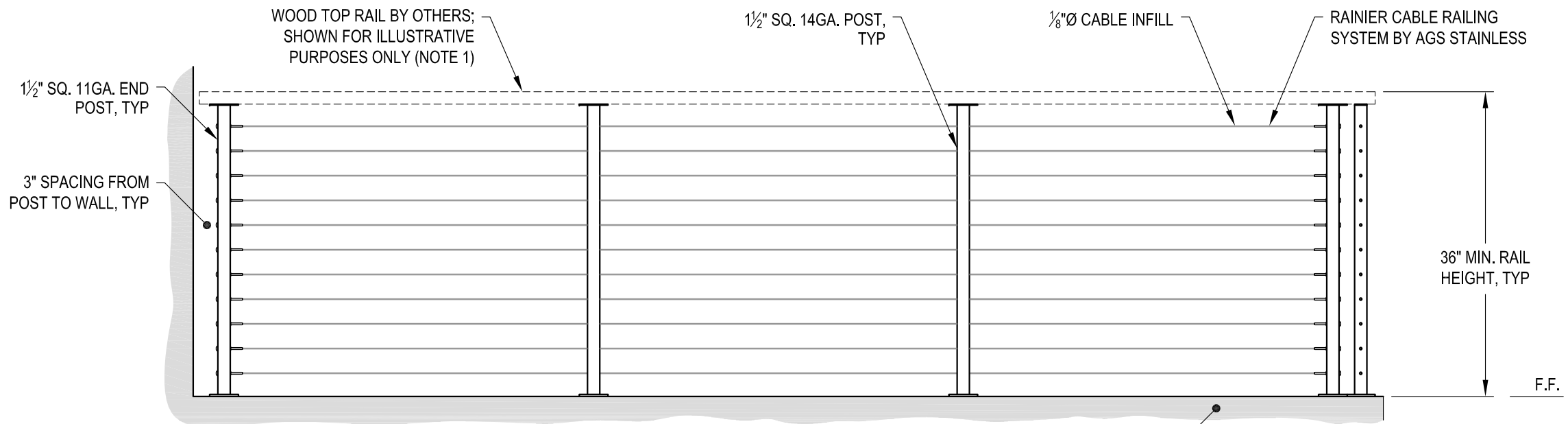

END POST - WALL CONDITION

INTERMEDIATE POST CONDITION

SUPPORTING
STRUCTURE (NOTE 2)

CORNER POST CONDITION

36" MIN. RAIL
HEIGHT, TYP

F.F.

A TYPICAL RAILING CONDITION
ELEVATION

DATE	2024	DESIGNER	AGS	SHEET	2 OF 4
SCALE	NONE				
RRAINER TM36W					

RAINER SPECIFICATION DRAWING
** RESIDENTIAL **

36" TOP MOUNT - WOOD TOP

7873 NE DAY ROAD
BAMBRIDGE ISLAND, WA 98110
PHONE - (888) 842-9492
FAX - (206) 842-4317
WWW.AGSSTAINLESS.COM



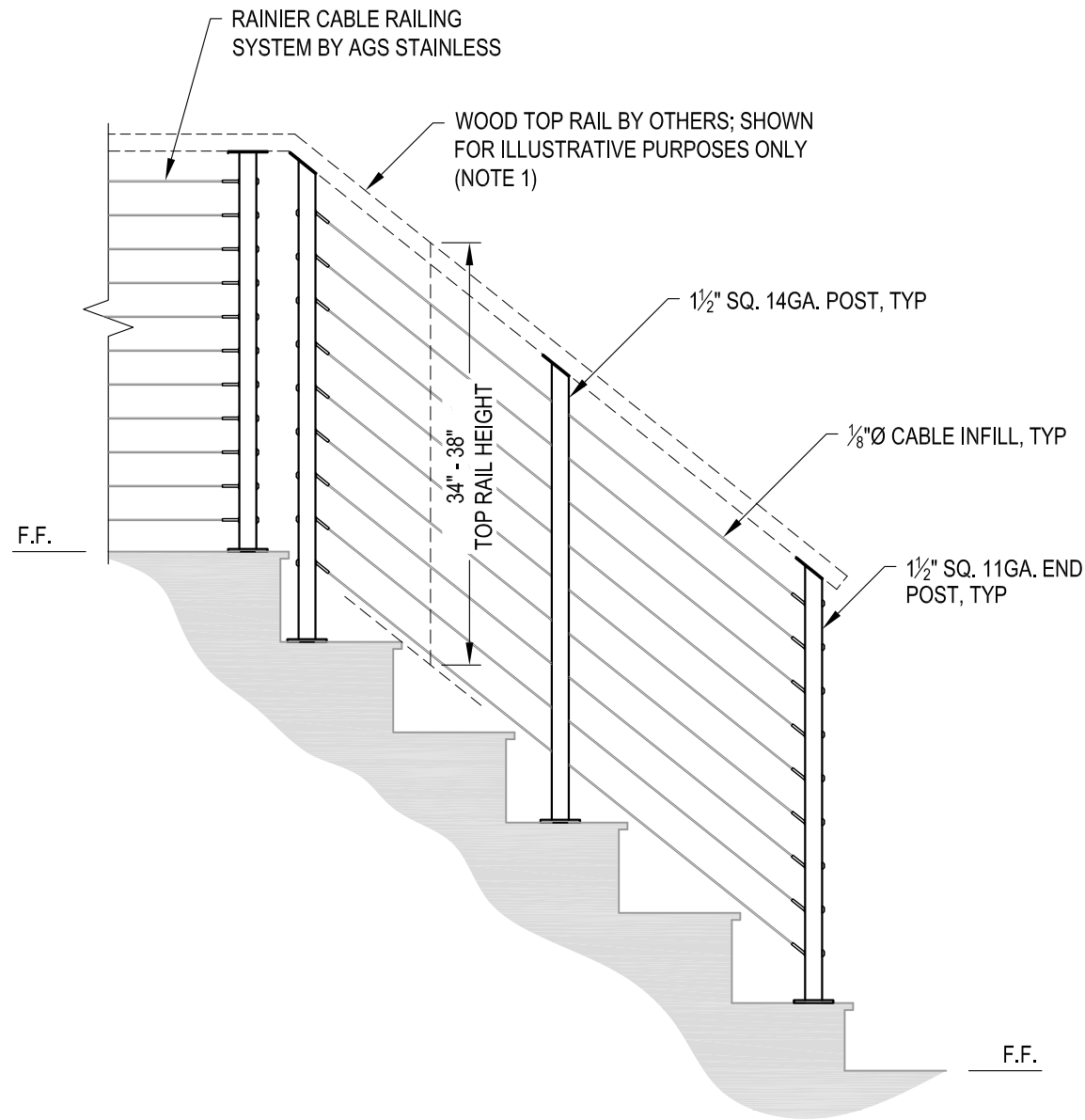

A STAIR ELEVATION

NOTES:

1. TOP RAIL SHOULD BE SELECTED SO THAT ALL GOVERNING CODE REQUIREMENTS ARE SATISFIED. THESE INCLUDE SHAPE, STRENGTH AND RAILING HEIGHT.
2. STAIR CONSTRUCTION VARIES GREATLY. AS-BUILT CONDITIONS MAY ALTER RAILING DESIGN, INCLUDING POST LOCATION & MOUNTING, INFILL SPACING & TOP RAIL LAYOUT.

DWG# RAINIER TM36W SCALE NONE DESIGNER AGS	DATE 2024 SHEET 3 OF 4
	RAINIER SPECIFICATION DRAWING ** RESIDENTIAL ** 36" TOP MOUNT - WOOD TOP
7873 MEADY ROAD BAINBRIDGE ISLAND, WA 98110 PHONE - (888) 842-9492 FAX - (206) 842-4317 WWW.AGSSTAINLESS.COM	

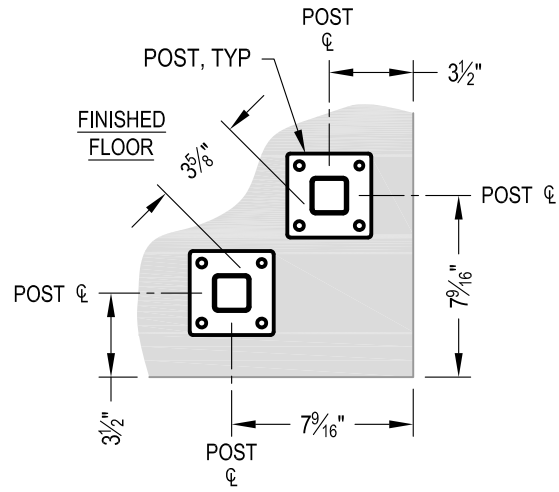

NOTE: 90° SHOWN, OTHER ANGLES SIMILAR

A TYPICAL 90° TOP MOUNT OUTSIDE CORNER
DETAIL

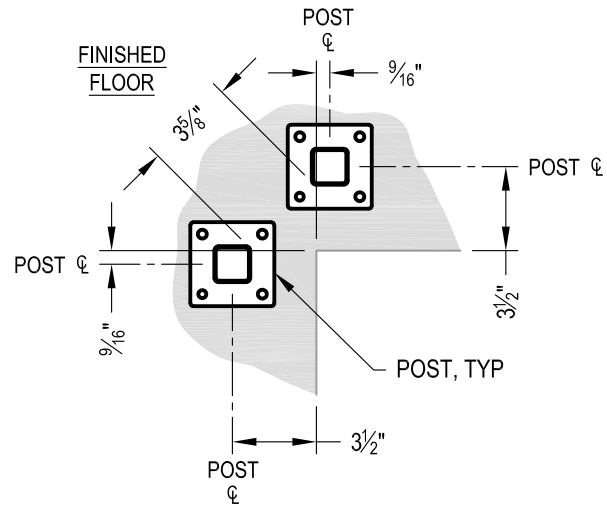

NOTE: 90° SHOWN, OTHER ANGLES SIMILAR

B TYPICAL 90° TOP MOUNT INSIDE CORNER
DETAIL

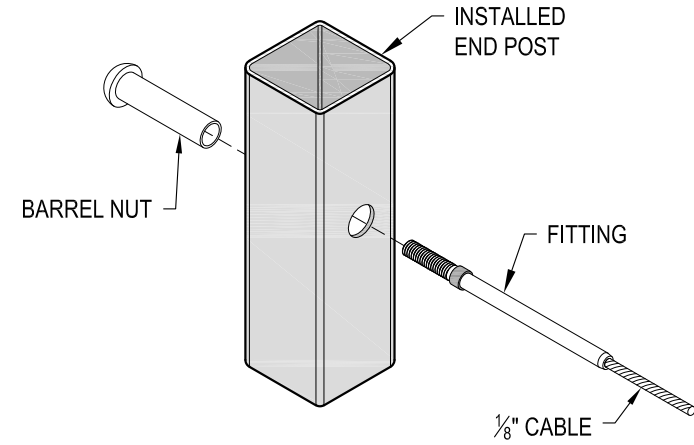

C FITTING INSTALLATION - BARREL NUT
DETAIL

DATE	2024
SCALE	NONE
DESIGNER	AGS
SHEET	4 OF 4

RAINIER SPECIFICATION DRAWING
** RESIDENTIAL **
36" TOP MOUNT - WOOD TOP

7873 MEADY ROAD
BAINBRIDGE ISLAND, WA 98110
PHONE - (888) 842-9492
FAX - (206) 842-4317
WWW.AGSSTAINLESS.COM

